

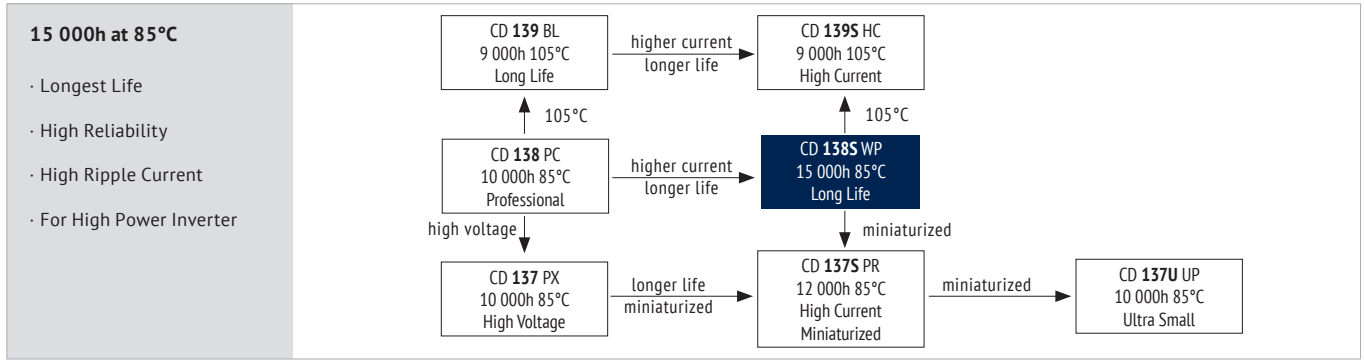

ALUMINUM ELECTROLYTIC CAPACITORS · SCREW TYPE

CD **138S** WP SERIES





ITEM CHARACTERISTICS

Operating Temperature Range (°C)	-40 ~ +85
Voltage Range (V)	350 ~ 500
Capacitance Range (µF)	1 500 ~ 12 000
Capacitance Tolerance (20°C, 120Hz)	± 20%

! The usage at lower temperatures than indicated may be possible. Please contact the Jianghai Europe sales office for approval.

Leakage Current: After 5 minutes at 20°C application of rated voltage, leakage current is not more than specified in table.

Stability at Low Temperature (Capacitance Ratio at 120Hz): $C_{-25°C} / C_{+20°C} \geq 0,7$

Fast Charge-Discharge: **!** Please contact Jianghai for an appropriate choice of the capacitor or possible technical adaptations, esp. for applications like: Welding, Photoflash, Servo motors, X-Ray

ITEM	USEFUL LIFE		LOAD LIFE	ENDURANCE TEST	SHELF LIFE	
Lifetime	15 000h	> 150 000h	10 000h	12 000h	1 000h	
Leakage Current	Not more than specified value		Not more than specified value	Not more than specified value	Not more than specified value	
Capacitance Change	Within ± 30% of initial value		Within ± 20% of initial value	Within ± 10% of initial value	Within ± 20% of initial value	
Dissipation Factor	Not more than 300% of specified value		Not more than 200% of specified value	Not more than 130% of specified value	Not more than 200% of specified value	
Condition:						
Applied Voltage	U_R	U_R	U_R	U_R	$U_R = 0$	After test: U_R to be applied for 30 min > 24h before measurement
Applied Current	I_R	$1,4 \times I_R$	I_R	$I_R = 0$	$I_R = 0$	
Applied Temperature	85°C	40°C	85°C	85°C IEC 60384	85°C	

Terminal and Construction: The terminal version has an impact on the current capability and mechanical behavior (vibration). For high current applications the terminals C,D and E are preferred, see page 151.

Optional: Self-extinguishing Electrolyte on request

MULTIPLIER FOR RIPPLE CURRENT (FREQUENCY COEFFICIENT)

Frequency	50Hz	120Hz	300Hz	1kHz	≥ 10 kHz
Coefficient	0,80	1,00	1,10	1,30	1,40

Multipliers for typical operating conditions.

MULTIPLIER FOR LIFETIME (LIFETIME DIAGRAM)

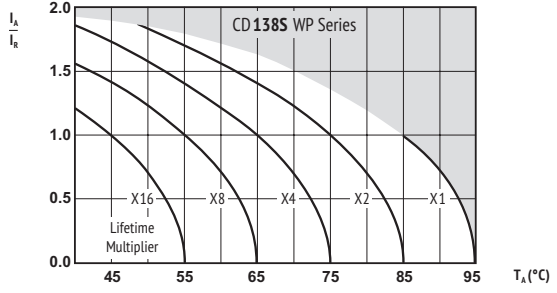

I_a = actual ripple current at 120Hz,
 I_r = rated ripple current at 120Hz, 85°C
 Multiplier of Useful Life as a function of ambient temperature & ripple current load

ENVIRONMENTAL

The products are RoHS, WEEE and REAcH compliant. The detailed version please see separate "Environmental Certificates" document or www.jianghai-europe.com

! SAFETY FACTOR

This diagram includes a safety margin. In many cases the allowed current capability/lifetime may be increased. For details and approvals please contact the Jianghai Europe sales office.





U_{RDC} (Surge Voltage) Code	C_R Rated Capacitance	ESR_{max} Equivalent Series Resistance 20°C 120Hz	ESR_{typ} Equivalent Series Resistance 20°C 120Hz	$\tan\delta$ Dissipation Factor 20°C 120Hz	I_{leak} Leakage Current	I_{RAC} Rated Ripple Current 85°C 120Hz	Size $\phi D \times L$	ORDER CODE ◇ = mounting style (stud) △△△△ = terminal style Details: Page 4
(V)	(μF)	(m Ω)	(m Ω)		(mA)	(Arms)	(mm)	
350 (400) 2V	3 900	50	25	0,15	5,0	14,6	64 x 96	ECC2VWP392M◇D096△△△△
	4 700	40	20	0,15	5,0	16,9	64 x 115	ECC2VWP472M◇D115△△△△
	5 600	34	17	0,15	5,0	19,8	64 x 130	ECC2VWP562M◇D130△△△△
		34	17	0,15	5,0	21,6	77 x 115	ECC2VWP562M◇E115△△△△
	6 800	28	14	0,15	5,0	25,0	77 x 143	ECC2VWP682M◇E143△△△△
		28	14	0,15	5,0	26,2	90 x 105	ECC2VWP682M◇F105△△△△
	8 200	24	12	0,15	5,0	29,3	77 x 143	ECC2VWP822M◇E143△△△△
		24	12	0,15	5,0	30,1	77 x 155	ECC2VWP822M◇E155△△△△
10 000	18	9	0,15	5,0	35,7	90 x 157	ECC2VWP103M◇F157△△△△	
12 000	16	8	0,15	5,0	39,1	90 x 157	ECC2VWP123M◇F157△△△△	
400 (450) 2G	2 700	76	38	0,15	5,0	11,5	64 x 96	ECC2GWP272M◇D096△△△△
	3 300	60	30	0,15	5,0	14,2	64 x 115	ECC2GWP332M◇D115△△△△
	3 900	52	26	0,15	5,0	16,5	64 x 115	ECC2GWP392M◇D115△△△△
		52	26	0,15	5,0	17,2	77 x 105	ECC2GWP392M◇E105△△△△
	4 700	42	21	0,15	5,0	18,1	64 x 130	ECC2GWP472M◇D130△△△△
		42	21	0,15	5,0	20,8	77 x 115	ECC2GWP472M◇E115△△△△
	5 600	36	18	0,15	5,0	22,7	77 x 130	ECC2GWP562M◇E130△△△△
		36	18	0,15	5,0	23,8	90 x 105	ECC2GWP562M◇F105△△△△
	6 800	30	15	0,15	5,0	26,6	77 x 155	ECC2GWP682M◇E155△△△△
		30	15	0,15	5,0	27,4	90 x 130	ECC2GWP682M◇F130△△△△
8 200	24	12	0,15	5,0	32,2	90 x 157	ECC2GWP822M◇F157△△△△	
10 000	20	10	0,15	5,0	35,7	90 x 157	ECC2GWP103M◇F157△△△△	
450 (500) 2W	2 200	92	46	0,15	5,0	10,4	64 x 96	ECC2WWP222M◇D096△△△△
		92	46	0,15	5,0	11,5	77 x 80	ECC2WWP222M◇E080△△△△
	2 700	76	38	0,15	5,0	12,8	64 x 115	ECC2WWP272M◇D115△△△△
	3 300	60	30	0,15	5,0	15,2	64 x 130	ECC2WWP332M◇D130△△△△
		60	30	0,15	5,0	15,8	77 x 105	ECC2WWP332M◇E105△△△△
	3 900	54	27	0,15	5,0	16,5	64 x 130	ECC2WWP392M◇D130△△△△
		54	27	0,15	5,0	18,0	77 x 115	ECC2WWP392M◇E115△△△△
	4 700	42	21	0,15	5,0	20,8	77 x 143	ECC2WWP472M◇E143△△△△
		42	21	0,15	5,0	21,8	90 x 105	ECC2WWP472M◇F105△△△△
	5 600	36	18	0,15	5,0	24,2	77 x 143	ECC2WWP562M◇E143△△△△
		36	18	0,15	5,0	24,9	90 x 130	ECC2WWP562M◇F130△△△△
	6 800	30	15	0,15	5,0	29,4	90 x 157	ECC2WWP682M◇F157△△△△
	8 200	24	12	0,15	5,0	32,2	90 x 157	ECC2WWP822M◇F157△△△△
	10 000	20	10	0,15	5,0	36,9	90 x 171	ECC2WWP103M◇F171△△△△
500 (550) 2H	1 500	148	74	0,15	5,0	8,6	64 x 96	ECC2HWP152M◇D096△△△△
	1 800	132	62	0,15	5,0	10,0	64 x 115	ECC2HWP182M◇D115△△△△
	2 200	102	51	0,15	5,0	11,7	64 x 130	ECC2HWP222M◇D130△△△△
	2 700	82	41	0,15	5,0	15,0	77 x 115	ECC2HWP272M◇E115△△△△
	3 300	68	34	0,15	5,0	17,5	77 x 130	ECC2HWP332M◇E130△△△△
	3 900	58	29	0,15	5,0	20,2	77 x 143	ECC2HWP392M◇E143△△△△
	4 700	48	24	0,15	5,0	21,8	90 x 130	ECC2HWP472M◇F130△△△△
	5 600	40	20	0,15	5,0	25,3	90 x 157	ECC2HWP562M◇F157△△△△
6 800	32	16	0,15	5,0	29,0	90 x 171	ECC2HWP682M◇F171△△△△	





ORDER CODE SCREW TYPE

EC	G		2G		BP		102		M		B		E		160		A771	-	JExxxxx	
Techno- logy	Terminal Type		Rated Voltage Code		Series Code		Capacitance Code		Capacitance Tolerance		Mounting		Diameter		Length		For Terminal Code see tables on the right	Material Code	for Specials only	
EC = Electrolytic Capacitor	Screw	G	10	1A	CD 135	BP	100	101	±20%	M	Bolt	B	36	A	53	053	-	-		
			16	1C	CD 136	PK	1 000	102	±10%	K	Flat bottom, no bracket, single sleeve	N	40	B	65	065	PVC	V		
			25	1E	CD 137	PX	10 000	103	+30/-10%	Q	Flat bottom, no bracket, full double sleeve	D	51	C	96	096	PET	E		
			35	1V	CD 137S	PR			+20/-0%	R	Flat bottom incl. 2 stoppers bracket	I	64	D	100	100	Polyolefin	O		
			40	1G	CD 137U	UP			+20/-10%	V	Flat bottom incl. 3 stoppers bracket	Y	77	E	115	115				
			50	1H	CD 138	PC			+50/-10%	T			90	F	236	236				
			63	1J	CD 138S	WP							101	G						
			80	1K	CD 139	BL														
			100	2A	CD 139S	HC														
			200	2D	CD 13H	BH														
			250	2E	CD 838	ZT														
			350	2V																
			400	2G																
			420	2X																
			450	2W																
			500	2H																
			550	2Y																
			575	2Z																
			600	2S																
			650	S6																

■ = preferred

Details of Slewing see table on the right

Standard:
PVC Sleeve





TECHNICAL SPECIFICATION

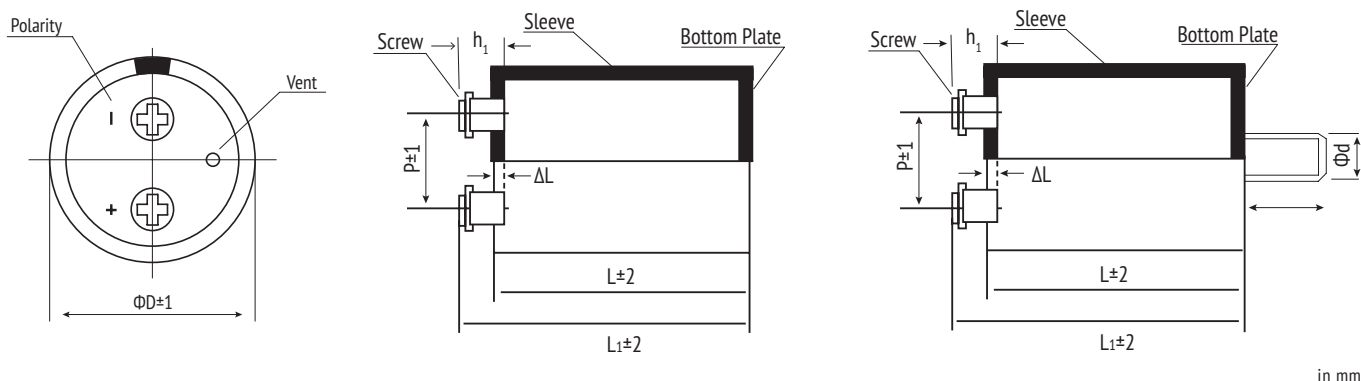

in mm

LENGTH

$L_1 = L + h_1 - \Delta L$
L_1 = Total Capacitor Length
L = Capacitor Case Length (see Capacitor Table)
h_1 = Terminal Length (see Terminal Code)
ΔL = Housing Correction (see Case & Mounting Style)

TERMINAL CODE

Terminal Code (cont. page 6)	ØD	Screw	Pitch P	d ₁	d ₂	h ₁	h ₂
A361	36	M5	12,7	8	11	6,8	1,8
A511	51	M5	21,8	10	13,5	6,8	1,8
A513	51	M5-/M6+	21,8	10	13,5	6,8	1,8
D511	51	M5	21,8	10	13	5,5	0
D512	51	M5	21,8	10	13	7,14	0
E511	51	M5	21,8	10	13,5	6,8	1,8
C641	64	M5	28,5	13	0	7,2	0
D641	64	M5	28,2	13	15	6,4	0
D642	64	M6	28,2	13	15	6,4	0
D643	64	M5	28,2	13	15	7,14	0
E641	64	M5	28,2	10	15,5	6,3	1,3
E645	64	M5-/M6+	28,2	10	15,5	6,3	1,3
B771	77	M6	31,4	17,2	0	3,17	0
B773	77	M8	31,4	17,2	0	3,17	0
B778	77	M5	31,4	17,2	0	10,4/6,4	0
C771	77	M5	31,4	17,2	0	3,5	0
C772	77	M6	31,4	17,2	0	3,5	0
C774	77	M5	31,4	17,2	0	6,4	0
C775	77	M6	31,4	17,2	0	6,4	0
C779	77	M6	31,4	13	0	5,5	0
D771	77	M5	31,4	13	15	6,4	0
D774	77	M5	31,4	13	14,2	6,4	0
D775	77	M5	31,4	13	15	7,14	0
E772	77	M5	31,4	10	15,5	6,3	1,3
A901	90	M5	31,4	10	15,5	6,3	1,3
B901	90	M6	31,4	17,2	0	6,4	0
B902	90	M5	31,4	17,2	0	6,4	0
B903	90	M5	31,4	17,2	0	10,4/6,4	0
C902	90	M6	31,4	17,2	0	6,4	0
C906	90	M5	31,4	17,2	0	6,4	0
D901	90	M5	31,4	10	13	5,5	0
D902	90	M5	31,4	13	15	6,4	0
D903	90	M6	31,4	13	15	6,4	0
E903	90	M5	31,4	10	15,5	6,3	1,3
A101	101	M8	41,5	17,2	21,5	11	6

CASE & MOUNTING STYLE

Order Code	Mounting Style	Sleeving Style (typical design)	Housing Correction ΔL (in mm)
B	Bolt	Single Sleeve	0,8
N	Flat bottom, no bracket	Single Sleeve	0,8
D	Flat bottom, no bracket	Full length Double Sleeve	0,4
I	I-Type Bracket	Diameter 36: Single Sleeve	0,8
		Diameter 51-101: Ur < 350V: ½ length Double Sleeve	0,6
		Ur ≥ 350V: full length Double Sleeve Other Sleeve Versions on request	0,4
Y	Y-Type Bracket	Ur < 350V: ½ length Double Sleeve	0,6
		Ur ≥ 350V: full length Double Sleeve Other Sleeve Versions on request	0,4

Bolt:	Ø D	Ø d	l (mm)	Max. Torque (Nm)
	Ø 36	M8	12	4
	≥ Ø 51	M12	16	12,5

SCREW TERMINAL (Hexagon Head)

Dimension	Min. Thread Depth (mm)	Max. Torque (Nm)	Max. Ripple Current (A)
M5 x 10	8,5	3	60
M6 x 12	8,5	4	100
M8 x 16	8,5	6	100

CAPACITOR POSITION

Screw capacitors need to be mounted into an upright position.
! If a horizontal position is needed please ensure the safety vent is located on the highest position (12 o'clock).

■ = preferred

Other forms on request, especially non-symmetrical layout, watercooling or laser welded terminals.

Terminal A101 = A991

Terminal A, B and F include a potting mass filling, Terminal C, D and E use a middle pin fixation without glue.

Extended Cathode designs only available with Terminal C, D and E.

Some series of the catalogue might only be available with Terminal C, D and E.





TERMINAL FORM (C, D, E preferred; other designs on request)

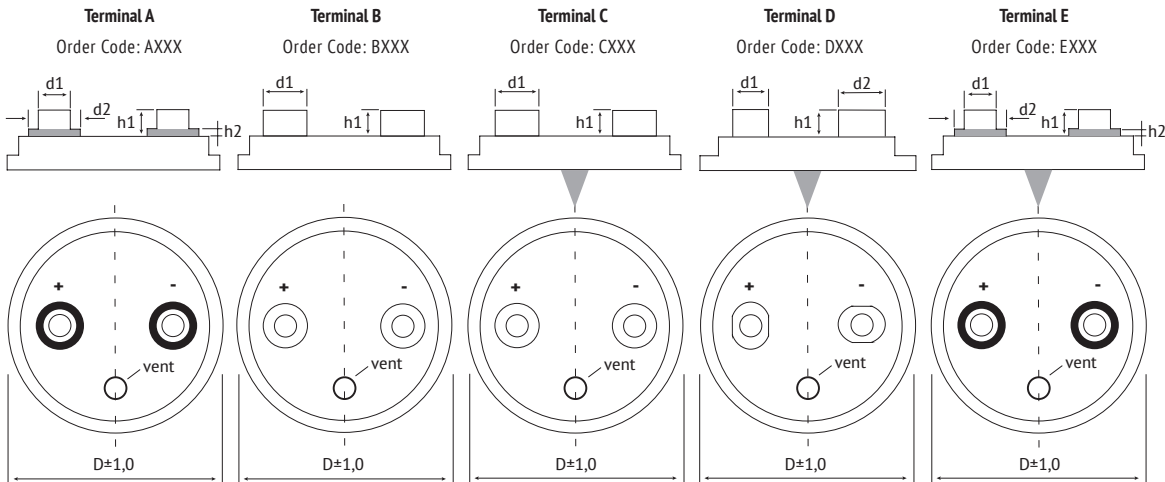

BRACKET MOUNTING

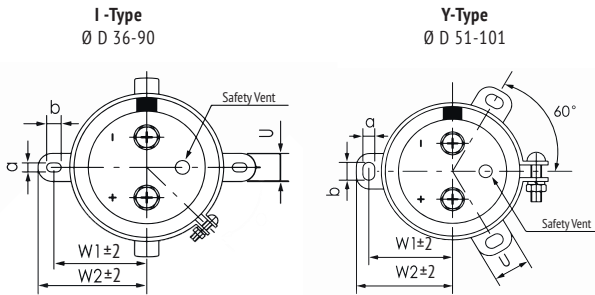

ØD	I-bracket						Y-bracket					
	w ₁	w ₂	a	b	U	h	w ₁	w ₂	a	b	U	h
36	24	29	3,8	7	10	15	-	-	-	-	-	-
51	34	40	5	7	14	30	31,8	36,5	5	7	14	30
64	40,5	46,5	5	7	14	30	38,1	42,6	5	7	14	30
77	46,8	53	5	7	14	30	44,5	49,2	5	7	14	30
90	54	60,3	5	7	14	30	50,8	55,6	5	7	14	30
101	-	-	-	-	-	-	57,5	63,5	5,5	8	20	35

■ = preferred
h = Height of brackets

in mm

ACCESSORIES FOR BOLT MOUNTING (Other accessories on request)

Cap Nut
Order Code: ACCNUT3038M12
For Screw Capacitors with M12 Bolt

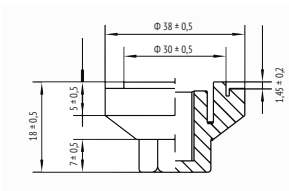

Cap Nut
Order Code: ACCNUT2230M12
For Screw Capacitors with M12 Bolt

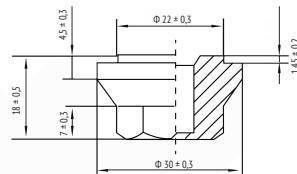

Insulation Washer
Order Code: ACCIS05113
For Screw Capacitors with Diameter 51 and 64

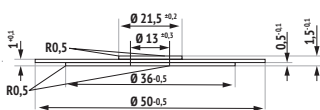
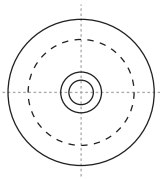

Insulation Washer
Order Code: ACCIS07713
For Screw Capacitors with Diameter 77 and 90

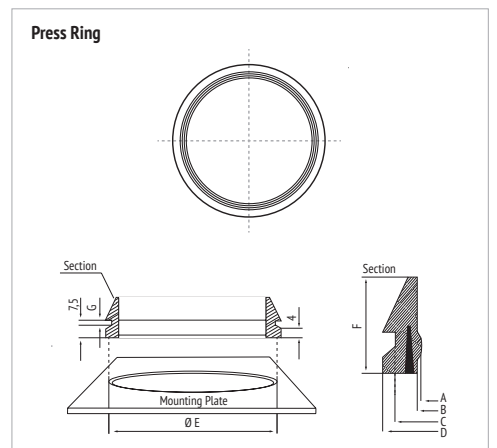
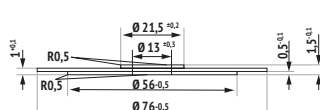
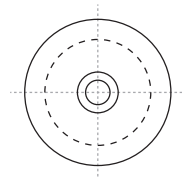

Ø Capacitor	64	77	90
A +0,3	62,3	74,8	88,0
B +0,3	64,1	77,0	90,0
C +0,3	70,5	84,5	97,9
D +0,3	74,5	88,6	102,0
E +0,2	71,2	85,5	98,6
F +0,2	18,0	20,0	23,5
G -0,25	3,0	2,4	3,0
Product Code Agree with RoHS	ACC PR164	ACC PR177	ACC PR190
Product Code Agree with RoHS and UL-94-V0	ACC PR464	ACC PR477	ACC PR490

All dimensions in mm



WARNING

JIANGHAI is not liable for any extent of possible injuries or damages to persons or things, of any kind, caused by the improper application of and/or operating conditions harmful to electrolytic capacitors. Misapplications which may cause failures include, but are not limited to: ripple current or peak current or voltage above specification, operating voltage above surge voltage specified, temperature exposure outside the specified operating temperature range. Examples of harmful operating conditions comprise, but are not limited to: unusual storage or transport temperatures, excessive and/or rapid changes of ambient temperature or humidity, heavy mechanical shock or vibration, corrosive and abrasive particles in the ambient (cooling) air, conducting dust in the ambient (cooling) air, oil or water vapor or corrosive substances, explosive gas or dust, operation under extremely high or low ambient pressure conditions (below or above sea level), superimposed radio frequency voltages, radioactivity. In case of doubt about the impact of operating conditions on capacitor performance, please contact JIANGHAI.

PERSONAL SAFETY

Electrical or mechanical misapplication of electrolytic capacitors may be hazardous. Personal injury or property damage may result from explosion of a capacitor or from the expulsion of electrolyte due to mechanical disruption or the release of a safety vent of a capacitor. In case of injury or skin or eye exposure to electrolyte, immediately seek professional medical advice. Before using electrolytic capacitors in any application, please read these Handling Precautions, familiarizing thoroughly with the information contained herein. Please check before using any of our electrolytic capacitors if these components fulfill the requirements of your application and that warnings and instructions for use are followed.

WARRANTY

The information contained in this catalogue does not form part of any quotation or contract, is believed to be accurate, reliable and up to date. Quality data are based on the statistical evaluations of a large quantity of parts and do not constitute a guarantee in a legal sense. However, agreement on these specifications does mean that the customer may claim for replacement of individual defective capacitors within the terms of delivery. We will not assume any liability beyond the replacement of defective components. This applies in particular to any consequential damage caused by component failure. Furthermore it must be taken into consideration that the figures stated for lifetime, failure rates and outlier percentages refer to the average production status and are therefore to be understood as mean values (statistic expectations) for a large number of delivery lots of identical capacitors. These figures are based on application experience and data obtained from preceding tests under normal conditions, or – for purpose of accelerated aging – more severe conditions. JIANGHAI reserves the right to change these specifications without prior notice. Any application information given is advisory and does not form part of any specification. The products are not primarily designed for use in life support applications, devices or systems where malfunction of these products can reasonably be expected to result in personal injury. JIANGHAI customers using or selling these products for use in such applications without prior written consent of JIANGHAI do so at their own risk and agree fully to indemnify JIANGHAI for any damage resulting from such improper use or sale. This version of the catalogue supersedes all previous versions. Latest versions of datasheets can be found on our homepage: www.jianghai-europe.com. For more details on precautions and guidelines for aluminum electrolytic capacitors, please refer to CENELEC Technical Report CLC/TR 50454:2008 E, "Guide for the application of aluminum electrolytic capacitors".

POLARITY

Electrolytic capacitors are polar and shall never be used with incorrect polarity, as there is a possible danger of shorting or destruction.

RATED VOLTAGE U_R

The rated voltage is marked on the capacitor and defined in the datasheets as U_R . This voltage should never be exceeded and is the maximum peak voltage including any ripple voltages allowed to avoid a shortening of the lifetime or damage of the capacitor. When a ripple current is applied to the capacitor, the sum of the peak ripple voltage and bias DC voltage shall never exceed the rated voltage. It might be necessary to lower the maximum allowed bias DC voltage, when certain ripple currents are applied to the capacitor.

SURGE VOLTAGE

Maximum voltage, which may be applied to the capacitor for short periods of time: max. 1000 cycles of 30 sec. per 6 min., max. 5 pulses per hour. Capacitance drift +/- 15% max.

REVERSE VOLTAGE

Reverse voltages or voltages < 0V are not allowed.

RECOVERY VOLTAGE

Electric potential between the positive and negative terminal may exist as a result of dielectric absorption. Please take action that this load does not damage other devices or scare workers during the production process (sparks possible). If needed please discharge the capacitor through a 1k Ω resistor.

TEMPERATURE RANGE

Use electrolytic capacitors only within the specified operating temperature range.

OVER-CURRENT

Currents exceeding the rated ripple currents should be avoided.

RIPPLE CURRENT/VOLTAGE

The combined value of DC voltage and peak AC voltage (due to ripple current) shall not exceed the rated voltage and shall never be < 0V. Use of aluminum electrolytic capacitors under ripple current with wide amplitudes is equivalent to rapid charge-discharge operation. Never exceed a ripple voltage of 70V_{peak-peak} without additional approval of Jianghai.

RAPID CHARGING/DISCHARGING

Rapid charging/discharging generates severe heat and gas may be emitted which may lead to explosion. Consult JIANGHAI about specially designed capacitors suitable for such kind of applications. Example: Servo Drive Application

BALANCING RESISTORS

Balancing resistors should be utilized if capacitors are used in serial connection. Please choose low-tolerance resistors to limit voltage drift.

CHARGE-DISCHARGE PROOF

JIANGHAI capacitors are charge-discharge proof, which means that 10⁶ switching cycles will cause capacitance reduction of less than 10%.

LIFETIME

There are many different lifetime definitions known without any true standard definition. Take special care when capacitors are compared that the capacitors fulfill the needed requirements. JIANGHAI publishes all conditions to be as transparent as possible. In the case of lifetime tests with additional ripple currents, the bias DC voltage must be reduced, so that the sum of bias DC voltage and the peak of the ripple voltage does not exceed the Rated Voltage U_R .

Load life: Period of time, during which the technical parameters of all capacitors stay within the given limits. JIANGHAI defines this without allowing for outliers.

Shelf Life: Definition of time with acceptable drift of capacitor parameters after storage at upper category temperature without load.

VIBRATION AND MECHANICAL STRESS

Capacitors are sensitive to vibration and mechanical forces applied on the leads. Do not use capacitors, which have been dropped onto a rigid surface.

INSULATION

If any defect of the sleeve is visible, the component should not be used – the same holds for any kind of visible damage. A capacitor should be electrically isolated from the following parts: aluminum case, cathode lead wire, anode lead wire and circuit pattern, and auxiliary terminal of snap-in type. The sleeve is not recognized as an isolator and therefore the standard capacitor should not be used in a place where insulation function is needed. Please contact JIANGHAI if a higher grade of insulation is required.

ENVIRONMENTAL CONDITIONS

Avoid direct contact with water, salt solution, oil, dewing conditions. Halogens generally, especially fumigation treatment with bromides and flame retardant agents containing halogens must be avoided. Avoid exposing to direct sunshine, ozone, ultraviolet rays and x-ray radiation. Air Pressure: Max. 150kPa, min. 8kPa. For usage >2000m altitude above sea level current deratings might be necessary. No heavy air pressure changes are allowed. Do not use or store in an environment containing any hazardous gas (e.g., hydrogen sulphide, sulphurous acid, nitrous acid, chlorine, ammonia, bromine, methyl bromide, other halogens) or acidic or alkaline solutions.

STORAGE

Temperature 5 to 35°C, relative humidity below 75%. Electrolytic capacitors may accumulate charge naturally during storage. In this case discharge through a 1k Ω resistor before use (Recovery voltage). Leakage current may be increased after long storage time. In this case the capacitor should be subjected to the rated voltage treatment through a 1k Ω resistor before use for 1 hour, then it should be discharged through a resistor of about 1 Ω /Volt. Storage times above 1 year should be avoided or rated voltage treatment may be necessary. In accordance to IEC 60384-4 electrolytic capacitors are subject to a reforming process before acceptance testing. Rated voltage is applied via a series resistance (100 Ω : U_R \leq 100VDC, 1k Ω : U_R > 100VDC).

SOLDERING

Soldering conditions (temperature, times) should be within specified conditions, especially for SMT components. Avoid high soldering temperatures as this may reduce lifetime or damage the capacitor. Do never dip the capacitor body into molten solder. Flux should not be adhered to the capacitor's body but only to its terminals. For details and different methods please contact us.

GLUEING, CLEANING AND COATING

Do not use fixing agents or cleaning substances containing halogens. Do not use coating and moulding components that completely seal the capacitor from the environment. Also, never use solvents containing: halogenated hydrocarbons, alkali, petroleum, trichloroethylene/ethane, xylene, acetones, trichlorotrifluoroethane, tetrachloroethylene, methylenechloride, chloroform, acetates, ketones, esters, chlorides and bromides.

MOUNTING

Other devices, which are mounted near the capacitor, should not touch the capacitor. Additional heat coming from other components near the capacitor may reduce the lifetime of the capacitor. Do never bend or twist the capacitor after soldering to avoid stress on the leads. Capacitors are not protected against mechanical forces on the leads. Forces on the pins might damage the capacitor. No printed circuit board tracks are allowed between the lead pads of the capacitor.

TRANSPORT

Avoid fumigation and spraying insecticides (especially with bromides) in the import or export procedures which can cause corrosion. This applies also to the finished devices.

MAINTENANCE

Periodical inspection should be carried out for the capacitor: visual inspection to check pressure relief open or leakage of electrolyte, electrical characteristics as leakage current, capacitance, and dissipation factor.

ELECTROLYTE AND SEPARATOR PAPER

Electrolyte and separator paper used in aluminum capacitors may be flammable. Also, electrolyte is electrically conductive. Therefore, in case electrolyte gets in contact with PC board it may cause corrosion of circuit pattern or cause short circuit between patterns, and may lead to smoke generation or ignition in worst case.

CAUTION DURING USE OF CAPACITORS

Do not touch the terminals of capacitors. Keep the capacitor free from conductive solution, such as acids, alkali and so on. Ensure that the operating environment of the equipment into which the capacitor has been built is within the specified conditions mentioned in the catalogue or specification sheets.

SAFETY VENT

The safety vent needs some free space to open properly. Allow for free headroom of at least 2mm for diameter ≤16mm, more than 3mm for diameter 18-35mm, more than 5mm for case diameter 40mm and larger.

EMERGENCY ACTIONS

When the pressure relief vent is open and some gas blows out from the capacitor, please turn the main switch of the equipment off or pull out the plug from the power outlet immediately. During safety vent operation, extremely hot gas (>100°C) may blow out of the capacitors. Do not stand close to the capacitors. In case of eye contact, rinse the open eye(s) with clean water immediately. In case of ingestion, gargle with water immediately, do not swallow. Do not touch electrolyte but wash skin with soap and water in case of skin contact.

DEFINITION OF ELECTRICAL PARAMETERS

Separate documents as application notes, equivalent circuit diagrams and so on are available on request.

PACKAGING

Please refer to the data book for details. Further information is available on request.

DISPOSAL

Scrapped capacitors are classified as scrapped metal. For disposal they are handled as controllable industrial waste because of the nature of the contents (electrolyte). Most of the material is aluminum and cannot be completely burned.

Jianghai Europe Electronic Components GmbH
VERSION 9/2024

To estimate the Lifetime of a non-solid Aluminum Electrolytic Capacitor from Jianghai, the following formulas can be utilized. The Lifetime depends mainly on the ambient temperature, the ripple current and, within certain limits, the operating voltage applied. Other parameters may also affect the Lifetime. Moreover, L_0 can be interpreted in many different ways, which has a fundamental influence on the numerical result. Jianghai offers a high transparency by publishing the different typical definitions of Lifetimes in each datasheet. Lifetime estimations are approximations by nature. Please let JIANGHAI EUROPE confirm any result before using it. The formulas given here do not constitute part of a contract nor of a specification. The formulas do not cover additional aging effects of certain electrolytic systems or other chemical effects. Also the dimensions of the components may have an effect. Forced cooling or other additional cooling-methods have a strong impact on the Lifetime and are not covered by the formulas as defined. For the estimation and interpretation of Lifetime, a close collaboration with JIANGHAI EUROPE is strongly advised.

STRUCTURAL FORMULA

$$L = L_0 \cdot K_T \cdot K_R \cdot K_V$$

WHERE:

- | | | | |
|-------|---|-------|-----------------------|
| L | Total Lifetime | K_T | Temperature Factor |
| L_0 | Lifetime under Nominal Load at Upper Category Temperature (see catalogue) | K_R | Ripple Current Factor |
| | | K_V | Voltage Factor |

K_T TEMPERATURE FACTOR

Aluminum Electrolytic Capacitors follow roughly the 10K rule of Arrhenius. It is possible to estimate the Lifetime by rule of thumb: When the operational temperature is reduced by 10K, the Lifetime will double. The formula for K_T in detail is:

$$K_T = 2^{\frac{T_0 - T_A}{10K}}$$

WHERE:

- T_0 Rated Temperature
- T_A Ambient Temperature

FREQUENCY CORRECTION FACTORS:

If the actual Ripple Currents are not given at the same frequency like I_0 , correction factors need to be applied.

$$I_A = \sqrt{\left(\frac{I_{f1}}{F_{f1}}\right)^2 + \left(\frac{I_{f2}}{F_{f2}}\right)^2 + \dots + \left(\frac{I_{fn}}{F_{fn}}\right)^2}$$

K_R RIPPLE CURRENT FACTOR

To estimate the influence of ripple current on lifetime, Jianghai uses a safety factor K_i . Under certain conditions this value can be set to $K_i=2$, which is prolonging the lifetime. Please contact Jianghai Europe for details and approval.

$$K_R = K_i^A \frac{\Delta T_0}{10K}$$

WITH:

$$A = 1 - \left(\frac{I_A}{I_R}\right)^2$$

WHERE:

- I_A Actual Rated Ripple Current
- I_R Ripple Current at Upper Category Temperature (databook value)
- ΔT_0 Core Temperature Rise of the capacitor (typically 3,5 ~ 5K for $T_0 = 105^\circ\text{C}$ and 3,5 ~ 10K for $T_0 = 85^\circ\text{C}$, see databook value)
- K_i Basis, typically defined as

$T_0 = 105^\circ\text{C}$	$I_A > I_R$:	$K_i = 4$
	$I_A \leq I_R$:	$K_i = 2$
$T_0 = 85^\circ\text{C}$		$K_i = 2$

! Remark: Safety Factor K_i may be set as $K_i=2$ under certain defined conditions. Please contact Jianghai Europe for approval.

>>

K_V VOLTAGE FACTOR

For Radial and SMT Electrolytic Capacitors, this part of the formula has no impact ($K_V = 1$). But for some bigger capacitors like Snap-In and Screw-Terminal types with rated voltages above 160V, the operating voltage will affect their Lifetime. It is expressed as follows:

FOR:

$$0,6 \leq \frac{U_A}{U_R} \leq 1$$

$$K_V = \left(\frac{U_A}{U_R} \right)^{-2,5}$$

WHERE:

U_A Actual Operating Voltage

U_R Rated Voltage

FOR:

$$0 < \frac{U_A}{U_R} < 0,6$$

$$K_V = 3,59$$

FOR:

$$\frac{U_A}{U_R} > 1 \text{ not allowed}$$

$$K_V = 1$$

FOR: Radial and SMT Capacitors or $U_R \leq 160V$

$$K_V = 1$$

JIANGHAI ELECTROLYTIC CAPACITOR LIFETIME

ESTIMATION FORMULA (incl. Safety Factors):

$$L = L_0 \cdot 2^{\frac{T_0 - T_A}{10K}} \cdot K_i \left[1 - \left(\frac{I_A}{I_R} \right)^2 \right]^{\frac{\Delta T_0}{10K}} \cdot \underbrace{\left(\frac{U_A}{U_R} \right)^{-n}}_{K_V}$$

WITH TYPICAL VALUES:

$$T_0 = 105^\circ\text{C} \quad I_A > I_R : K_i = 4$$

$$I_A \leq I_R : K_i = 2$$

$$T_0 = 85^\circ\text{C} \quad K_i = 2$$

ΔT_0 = depending on the series: 3,5~10K,
see databook value

$$0,6 \leq \frac{U_A}{U_R} \leq 1 \rightarrow n = 2,5$$

$$0 < \frac{U_A}{U_R} < 0,6 \rightarrow K_V = \left(\frac{U_A}{U_R} \right)^{-n} = 3,59$$

For $U_R \leq 160V$, Radial and SMT

$$\frac{U_A}{U_R} > 1 \rightarrow K_V = 1$$

SCREW

