

FILM CAPACITORS · SNUBBER

# CBB 166 IG SERIES

**FEATURES**

- Very low dissipation factor
- Highest peak pulse capability
- Design for Snubber Application
- Self-healing
- Soldering Terminal

**OVERVIEW**

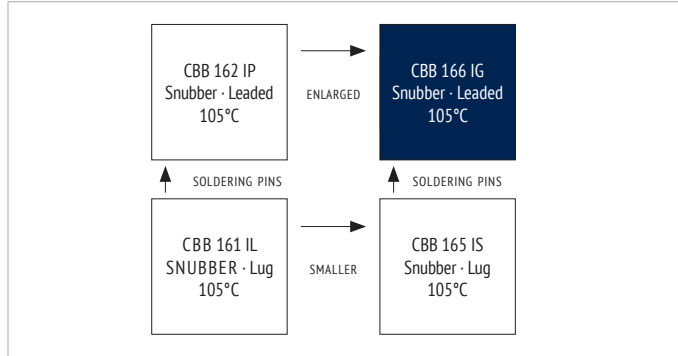

**PRODUCT**



**APPLICATIONS**

- High pulse and high frequency circuits
- IGBT applications

**CHARACTERISTICS**

ITEM	CHARACTERISTICS
Climatic Category	40/105/56 (IEC 61071)
Operating Temperature	-40 ~ +105 °C ( $\Theta_{hotspot} \leq 105$ °C) $\Theta_{hotspot} = 85-105$ °C: See Voltage Derating Diagram
Storage Temperature	-40 ~ +105 °C
Rated Voltage $U_{RDC}$	850 ~ 2 000 $V_{DC}$
Capacitance Range	0,033 ~ 5,0 $\mu F$
Capacitance Tolerance	$\pm 10$ % (K), $\pm 5$ % (J)
Voltage between Terminals $U_{TT}$	$1,5 * U_{RDC}$ (20 °C, 10s)
Voltage between Terminals & Case $U_{TC}$	$\geq 3 000 V_{AC}$ (20 °C, 50 Hz, 10s)
Capacitor Dissipation Factor $\tan \delta$	$\leq 1 * 10^{-3}$ (20 °C, 1 kHz)
Dielectric Dissipation Factor $\tan \delta_0$	$\leq 2 * 10^{-4}$ (20 °C, 1 kHz)
Insulation Resistance $R_i$ °C	$\geq 30 000 M\Omega * \mu F$ (20 °C, 100 $V_{DC}$ , 1 min)
Max. Overvoltage	Please see IEC 61071
Life Time Expectancy	$\geq 100 000h$ , failure rate $\leq 100$ FIT (70 °C)
Reference Standard	IEC 61071:2007

**ENVIRONMENTAL**

The products are RoHS, WEEE and REACH compliant.  
  
The detailed version please see separate "Environmental Certificates" document or [www.jianghai-europe.com](http://www.jianghai-europe.com)

**APPROVALS**

**UL94-V0:**  
  
Plastic & Compound Mass

**LIFETIME**

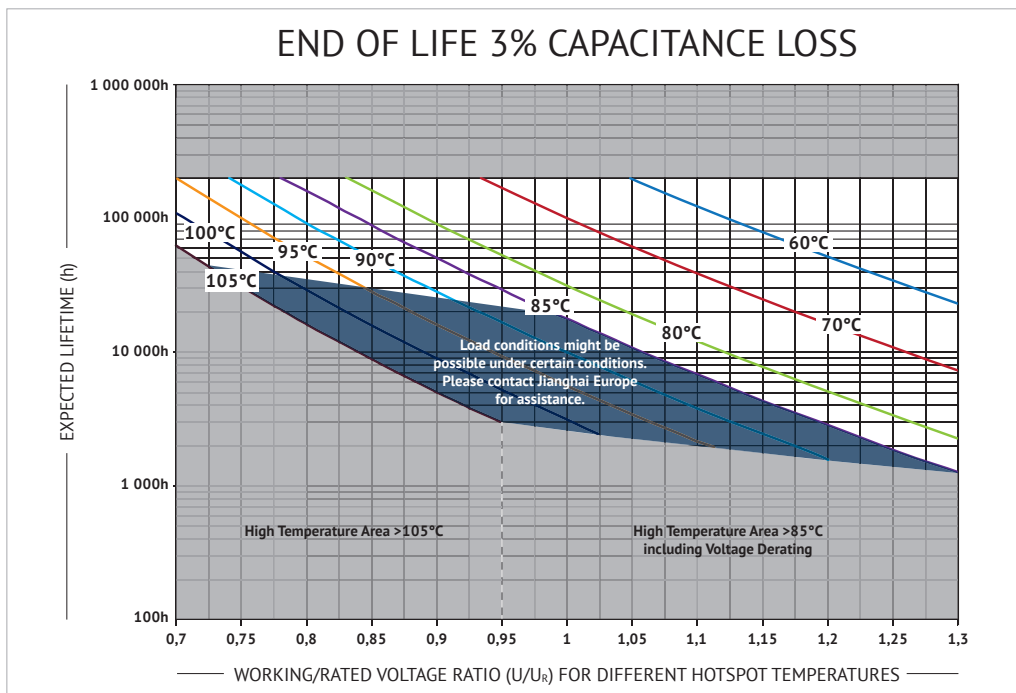

**CURRENT DERATING**

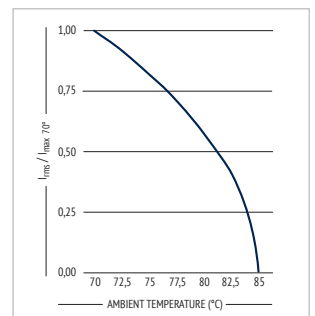

**VOLTAGE DERATING**

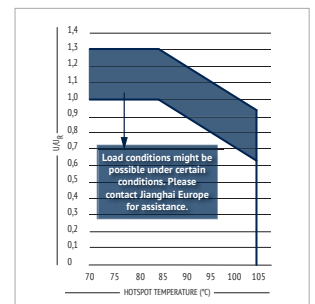

**DIMENSIONS**

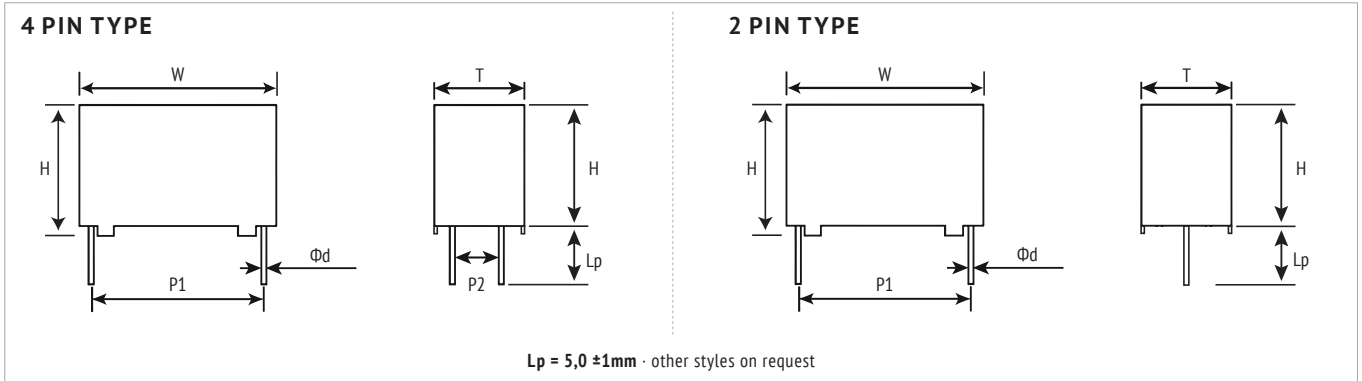

**INTERNAL CONSTRUCTION**

NO.	ITEM	MATERIAL
1	Dielectric Film	Polypropylene
2	Single-sided Metallized Film	PP + Al
3	Double-sided Metallized Carrier Film	PET + Al
4	Metal Sprayed Contact	Zn + Sn/Zn
5	Terminal	Sn-coated Cu
6	Potting Compound	Epoxy
7	Case	Flame retardant PBT

**MARKING**

**CBB 166**  
1µF J 1200V  
J08F15

BRAND: Jianghai  
PRODUCT SERIES: CBB 166  
CAPACITANCE, TOLERANCE AND RATED VOLTAGE: 1µF J 1200V  
DATE CODE: J08F15

**ORDER CODE**

FC	S	3B	IG	105	K	A	30	F2	F	0	C	E 3
Capacitor type	Product shape	DC rated voltage code (V)	Series code	Capacitance Code (µF)	Capacitance tolerance	Pin Style (mm)	Pin Length (mm)	Dimension Code (mm) W x H x T ±1,0 ±1,0 ±1,0	Pitch P <sub>1</sub> (mm)	Pitch P <sub>2</sub> (mm)	Leadwire Diameter Ød	For internal use
Film Cap. = FC	Square box = S	850 <b>K2</b> 1000 <b>3A</b> 1200 <b>3B</b> 1600 <b>3C</b> 2000 <b>3D</b>	CBB 166 = IG	0,047 <b>473</b> 0,68 <b>684</b> 0,82 <b>824</b> 1,0 <b>105</b> 1,2 <b>125</b>	±5% <b>J</b> ±10% <b>K</b>	2 Pin, straight leads cut 2 Pin, long leads 4 Pin, straight leads cut	0 1 2  long leads <b>00</b> <b>30</b> <b>32</b> <b>35</b> <b>50</b> <b>60</b> <b>A0</b> <b>A1</b> <b>A2</b>	<b>I4</b> <b>I7</b> <b>I8</b> <b>IC</b> <b>IF</b> <b>II</b> <b>F1</b> <b>F2</b> <b>F5</b> <b>F9</b> <b>FF</b> <b>HH</b> <b>HL</b>	<b>9</b> <b>C</b> <b>F</b>	<b>3</b> <b>9</b> <b>0</b>	<b>B</b> <b>C</b> <b>D</b>	



OVERVIEW SNUBBER

SNUBBER

APPLICATIONS:

- 1 High pulse an high frequency circuits
- 2 IGBT mounting

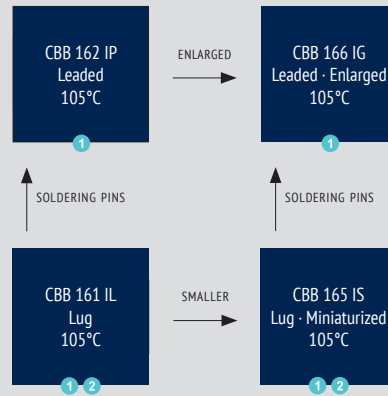

**WARRANTY** The information contained in this datasheet does neither form part of any quotation nor of a contract, it is believed to be accurate, reliable and up to date. Quality data are based on the statistical evaluations of a large quantity of parts and do not constitute a guarantee in a legal sense. However, agreement on these specifications does mean that the customer may claim for replacement of individual defective capacitors within the terms of delivery. We cannot assume any liability beyond the replacement of defective components. This applies in particular to any further consequences of component failure. Furthermore it must be taken into consideration that the figures stated for lifetime and failure rates refer to the average production status and are therefore to be understood as mean values (statistical expectations) for a large number of delivery lots of identical capacitors. These figures are based on application experience and data obtained from preceding tests under normal conditions, or – for purpose of accelerated aging – more severe conditions. JIANGHAI reserves the right to change these specifications without prior notice. Any application information given is advisory and does not form part of any specification. The products are not primarily designed for use in life supporting applications, devices or systems where malfunction of these products can reasonably be expected to result in personal injury. JIANGHAI customers using or selling these products for use in such applications without prior written consent of JIANGHAI do so at their own risk and agree fully to indemnify JIANGHAI for any damage resulting from such improper use or sale. This version of the datasheet supersedes all previous versions.

**NOMINAL CAPACITANCE  $C_R$**  Nominal Capacitance is defined at 20°C and 50Hz (120Hz).

**RATED VOLTAGE  $U_R$**

**DC Capacitors:**  $U_{RDC}$  Maximum operating peak voltage of either polarity but of a non-reversing type waveform, for which the capacitor has been designed, for continuous operation. The maximum DC voltage is the sum of the DC voltage and peak AC voltage.

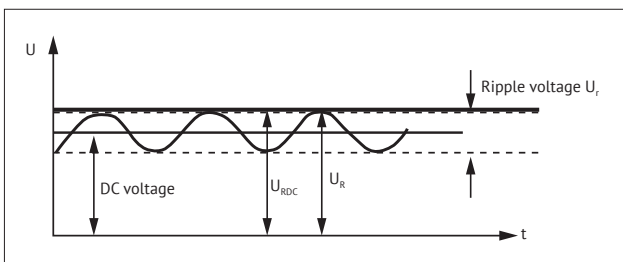

**AC Capacitors:**  $U_{RAC}$  Maximum operating peak recurrent voltage of either polarity of a reversing type waveform for which the capacitor has been designed.

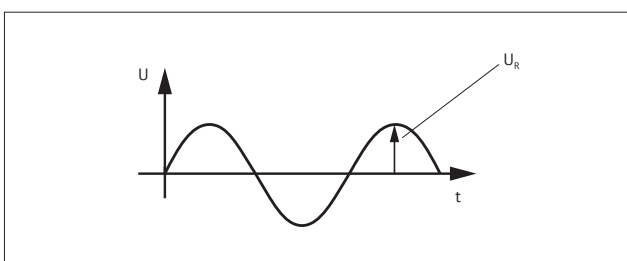

**OPERATING VOLTAGE** The plastic film capacitor varies in the maximum applicable voltage depending on the applied voltage waveform, current waveform, frequency, ambient temperature (capacitor surface temperature), capacitance value, etc. Be sure to use capacitors within the specified values by checking the voltage waveform, current waveform, and frequency applied to them (In the application of high frequency, the permissible voltage varies with the type of the capacitor. Refer to the specification for details. See also Voltage Derating tables.).

**NON-RECURRENT SURGE VOLTAGE  $U_s$**  Peak voltage induced by a switching or any other disturbance of the system which is allowed for a limited number of times and for durations shorter than the basic period.

- Maximum duration: 50 ms / pulse
- Maximum number of occurrences: 1000 (during load)

**MAXIMUM RATE OF VOLTAGE RISE  $dV/dt$**  Maximum permissible repetitive rate of voltage rise of the operational voltage.

**OPERATING CURRENT** Due to the fact that the dissipation factor of the capacitor is greater than zero, heat will be generated in any application where alternating currents or pulses occur. The resulting internal temperature rise may cause a severe deterioration of the capacitor's withstanding voltage, or may lead to a breakdown (even smoke or fire may result). Therefore, the safe use of capacitor must be within the rated voltage (or category voltage) and the permissible current ranges. The rated current must be considered by dividing into pulse current (peak current) and continuous current (rms current) depending on the break down mode, and when using, should make sure the both currents are within the permissible range.

**MAXIMUM CURRENT  $I_{MAX}$**  Maximum Rms Current for continuous operation, see Current Derating tables.

**MAXIMUM PEAK CURRENT  $\hat{I}$**  Maximum permissible repetitive peak current which can occur during continuous operation.

$$\hat{I} = C_R * (dV/dt)$$

**MAXIMUM SURGE CURRENT  $\hat{I}_s$**

- Maximum duration: 50 ms / pulse
- Maximum number of occurrences: 1000 (during load)

**SERIES RESISTANCE  $R_s$**  Effective ohmic resistance of the conducting elements of the capacitor.

**EQUIVALENT SERIES RESISTANCE ESR** The ESR represents all ohmic resistances:  $ESR = \tan\delta / (\omega C) = R_s + \tan\delta / (\omega C)$

**DIELECTRIC DISSIPATION FACTOR  $\tan\delta$**  Constant dissipation factor of the dielectric material.

**LOSS FACTOR  $\tan\delta$**  The dissipation factor is the ratio between the reactive and effective power.

**HOTSPOT TEMPERATURE  $\Theta_{HOTSPOT}$**  Temperature at the hottest position inside the capacitor.  $\Theta_{hotspot} = \Theta_{ambient} + P_{loss} * R_{th}$

$R_{th}$ : thermal resistance,  $P_{loss}$ : Powerloss  $P_{loss} = ESR * I_{rms}^2$ ,

$\Theta_{ambient}$  = ambient temperature

**CHARGING AND DISCHARGING** Because the charging and discharging current of capacitor is obtained by the product of voltage rise rate (dV/dt) and capacitance, low voltage charging and discharging may also cause deterioration of capacitor such as

shorting and open due to sudden charging and discharging current. When charging and discharging, pass through a resistance of 20Ω/V to 1000Ω/V or more to limit the current. When connecting multiple film capacitors in parallel in withstand voltage test or life test, connect a resistance of 20Ω/V to 1000Ω/V or more in series to each capacitor. In addition, **capacitors must be discharged via a resistor before handling**. Because the capacitors do not have any discharge resistors built-in, there is a risk of residual voltages and electric energy contents that might be dangerous.

**TEMPERATURE RANGE AND ALTITUDE** Use film capacitors only within the specified operating temperature range. The altitude and barometric pressure have an impact on the functionality of the capacitor. Max. Altitude: 2000m above sea level.

ALTITUDE/m	CURRENT DERATING COEFFICIENT
≤ 2 000	1,00
2 500	0,95
3 000	0,90
3 500	0,85
4 000	0,80
4 500	0,75
5 000	0,70

**EXPECTED LIFETIME** The expected lifetime of the capacitor depends on the applied voltage and the hot spot temperature during operation. For capacitors applied in different situations, the obtainable average service lives are different. Please refer to the life time diagrams of each series.

**FAILURE RATE λ (FAILURE IN TIME FIT)**  $1 \text{ FIT} = 1/10^9 \text{h}$  (1 failure per 10<sup>9</sup> components test hours),  $\lambda = r/(nt)$

r = number of failure, n = test number, t = test time

**INSULATION VOLTAGE U<sub>i</sub>** Rms value of AC voltage designed for the insulation between terminals of the capacitor to case or earth. The insulation voltage is equal to the rated voltage of the capacitor, divided by , unless otherwise specified.

**INSULATION RESISTANCE R<sub>i</sub>** Ration between applied DC Voltage and resulting leakage current after 1 minute of charge. It is defined in MΩ. Typically it is given as time constant R<sub>i</sub>\*C [μF] in seconds.

**VOLTAGE BETWEEN TERMINALS U<sub>TT</sub>** Voltage between terminals.

**VOLTAGE BETWEEN TERMINALS AND CASE U<sub>Tc</sub>** Voltage between terminals and case.

**BUZZING NOISE** Any buzzing noise produced by a capacitor is caused by the vibration of the film due to the Coulomb force that is generated between the electrodes with opposite poles. It is of no harm to the capacitor.

**DIELECTRICAL ABSORPTION** Due to the dielectrical absorption voltages may occur between the terminals. Please discharge the capacitor before usage.

**SURFACE OVER TEMPERATURE Δθ<sub>case</sub>** When current continuously flow through the capacitor, the temperature inside the capacitor will rise induced by dissipated heat. If the temperature exceeds the maximum allowed hot-spot temperature, it might

cause a short circuit or fire. The limits described in the catalogue must not be exceeded and it's necessary to check the temperature on the capacitor's surface in operation.

**FLAME RETARDATION** Although flame retarding PU resin or plastic case material is used in the coating or encapsulation of plastic film capacitors, continuous exposure to high temperature ambient or fire will break the coating layer or plastic case of the capacitor, and may lead to melting and ignition of the capacitor element.

**HUMID AMBIENT** If used for a long time in a humid ambient, the capacitor might absorb humidity and oxidize the electrodes causing damage to the capacitor. In case of AC application, high humidity would increase the corona effect. This phenomenon causes a drop in capacitance and an increase of capacitor losses. Humidity needs to be avoided. If needed please inform Jianghai separately for technical adopted components.

**STORAGE CONDITIONS** 1) Capacitors must not be stored in corrosive atmospheres, particularly not when chlorides, sulfides, alkali, acids, lye, salts, organic solvents or similar substances are present. 2) It must not be stored in high temperature and/or high humidity environments. The following storage conditions must be kept (applicable only for storage in the original package): Temperature: ≤ 35 °C; Humidity: ≤ 80% RH, no dew allowed on the capacitor; Storage time: ≤ 24 months

**MOUNTING** Other devices, which are mounted near the capacitor, should not touch the capacitor. Additional heat coming from other components near the capacitor may reduce the lifetime of the capacitor. Do never attempt to bend or twist the capacitor after mounting and avoid any mechanical stress on the terminals. Never exceed the max. permissible torques when tightening the terminal screws or the mounting bolt's cap nuts.

**CAUTION & WARNINGS** Do not touch the terminals of capacitors. The energy stored in capacitors may be lethal. Ensure that the operating environment of the equipment into which the capacitor has been built, is within the specified conditions. Capacitors must not be used in corrosive atmospheres, particularly not when chlorides, sulfides, alkali, acid, lye, salts, organic solvents or similar substances are present. Electrical or mechanical misapplication may be hazardous. Personal injury or property damage may result from bursting of the capacitors or from expulsion of melted material.

*Jianghai Europe E.C. GmbH, v6 0425*