

SOLID POLYMER CAPACITORS · STACKED CHIP TYPE

PC **HPS** PS SERIES

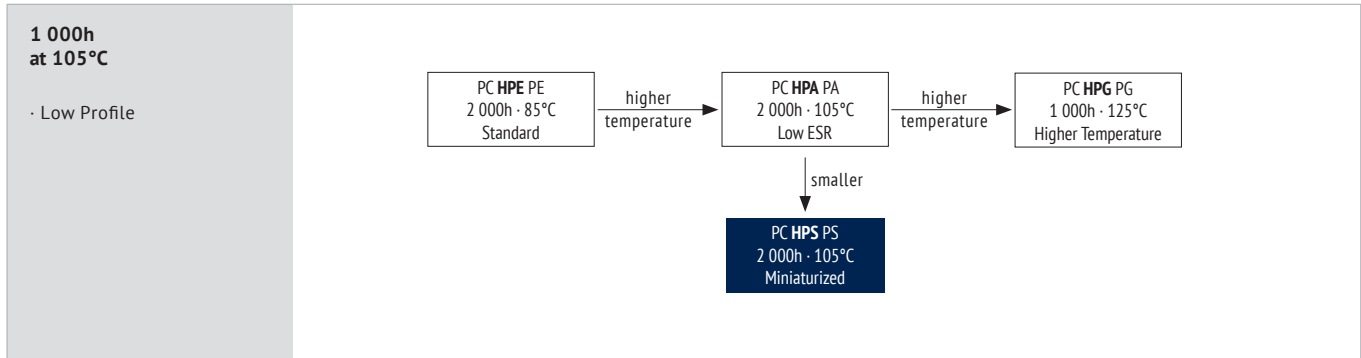

ITEM CHARACTERISTICS

Operating Temperature Range (°C)	-55 ~ +105
Voltage Range (V)	2 ~ 10
Capacitance Range (µF)	47 ~ 330
Capacitance Tolerance (20°C, 120Hz)	± 20%
Surge Voltage (V)	$U_R * 1,25$
Dissipation Factor	≤ 0,06
Endurance	$L_e = 2\ 000h$

! The usage at lower temperatures than indicated may be possible. Please contact the Jianghai Europe sales office for approval.

ITEM ENDURANCE LIFE $L_e = 2\ 000h$

Leakage Current	$U_R < 8V$: Not more than 300% of specific value $U_R \geq 8V$: Not more than specific value
Capacitance Change	Within ± 20% of initial value
Dissipation Factor	Not more than 200% of specified value
Condition	U_R applied at 105°C

DIMENSIONS

	L +0,3/-0,1	W_1 +0,3/-0,1	H +0,3/-0,1	P +/-0,3	W_2 +/-0,1
Type E	7,3	4,3	1,1	1,3	2,4
Type B	7,3	4,3	1,4	1,3	2,4

MULTIPLIER FOR RIPPLE CURRENT

TEMPERATURE (T)	$T \leq 45^\circ C$	$45^\circ C < T \leq 85^\circ C$	$85^\circ C < T \leq 105^\circ C$
2V - 6,3V	1,0	0,7	0,25
10V	1,0	0,8	0,5

ENVIRONMENTAL

The products are RoHS, WEEE and REACH compliant. The detailed version please see separate "Environmental Certificates" document or www.jianghai-europe.com

Additional information for storage condition please see page 4.

INTERNAL STRUCTURE PRINCIPLE (EXAMPLE)

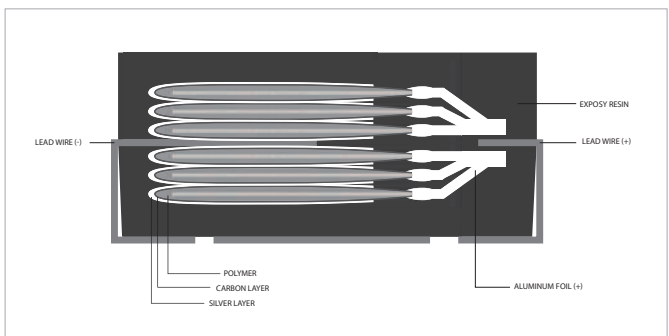

For detailed information, datasheets and samples please contact Jianghai Europe.

TYPE E

U_{RDC} (Code)	C_R Rated Capacitance 20°C, 120Hz	ESR_{max} Equivalent Series Resistance 20°C 100kHz	$\tan\delta$ Dissipation Factor 20°C 120Hz	I_{leak} Leakage Current 20°C 2min	I_{RAC} Rated Ripple Current 45°C 100kHz	Size Code	Dimension (mm)	ORDER CODE Details: Page 4
(V)	(μ F)	(m Ω)		(μ A)	(mA _{RMS})			
2,0 OD	220	6	0,06	44	7 500	E	7,3x4,3x1,1	PCP0DPS221M06EE3
2,5 OE	180	6	0,06	45	7 500	E	7,3x4,3x1,1	PCP0EPS181M06EE3
4 OG	120	15	0,06	48	5 100	E	7,3x4,3x1,1	PCP0GPS121M15EE3
6,3 OJ	68	15	0,06	43	5 100	E	7,3x4,3x1,1	PCP0JPS680M15EE3
10 1A	47	40	0,06	141	3 200	E	7,3x4,3x1,1	PCP1APS470M40EE3

TYPE B

U_{RDC} (Code)	C_R Rated Capacitance 20°C, 120Hz	ESR_{max} Equivalent Series Resistance 20°C 100kHz	$\tan\delta$ Dissipation Factor 20°C 120Hz	I_{leak} Leakage Current 20°C 2min	I_{RAC} Rated Ripple Current 45°C 100kHz	Size Code	Dimension (mm)	ORDER CODE Details: Page 4
(V)	(μ F)	(m Ω)		(μ A)	(mA _{RMS})			
2,0 OD	330	6	0,06	66	7 500	B	7,3x4,3x1,4	PCP0DPS331M06BE3
2,5 OE	270	6	0,06	68	7 500	B	7,3x4,3x1,4	PCP0EPS271M06BE3
4 OG	180	15	0,06	72	5 100	B	7,3x4,3x1,4	PCP0GPS181M15BE3
6,3 OJ	100	15	0,06	63	5 100	B	7,3x4,3x1,4	PCP0JPS101M15BE3
10 1A	68	40	0,06	204	3 200	B	7,3x4,3x1,4	PCP1APS680M40BE3

ORDER CODE SOLID POLYMER STACKED CHIP

PC	P	OD	PA	6R8	M	04	V	E3					
Technology	Terminal Type	Rated Voltage Code		Series Code		Capacitance Code μF		Capacitance Tolerance	ESR Code (mOhm)	Dimension Code (mm)		for internal use	
PC = Polymer Capacitor	Chip P	2V	0D	HPA	PA	6,8	6R8	$\pm 10\%$	K	4,5	04	7,3x4,3x1,9	V
		2,5V	0E	HPE	PE	68	680	$\pm 20\%$	M	6	06	7,3x4,3x2,8	D
		4V	0G	HPG	PG	470	471	-30~+10%	X	16	16	7,3x4,3x1,1	E
		6,3V	0J	HPS	PS			-35~+10%	W	60	60	7,3x3x1,4	B
		8V	0K					-35~+20%	Y				
		10V	1A										
		16V	1C										

STORAGE CONDITION

IN ADDITION TO THE DETAILS IN CHAPTER "HANDLING PRECAUTIONS" PLEASE NOTE:
▶ Moisture Sensitivity Level: MSL-3
▶ Recommended Storage: 5~30°C, max 60% RH within moisture proof bag
▶ Max. Storage time in original closed bag: 2 years
▶ After opening the bag please use the capacitors within 168h.
▶ When polymer capacitors are used first time after a period of storage, the leakage current might be increased. When voltages are applied within specified life time, the leakage current will decrease again due to the self-healing functionality. Please take action to protect the circuit against increase leakage currents.

RECOMMENDED SOLDERING PAD DIMENSIONS

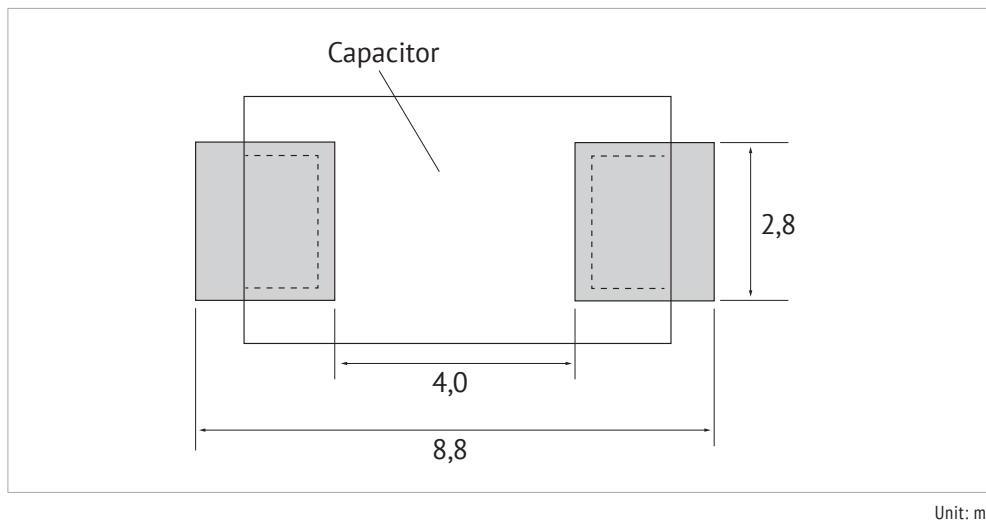

RECOMMENDED REFLOW PROFILE (<10V)

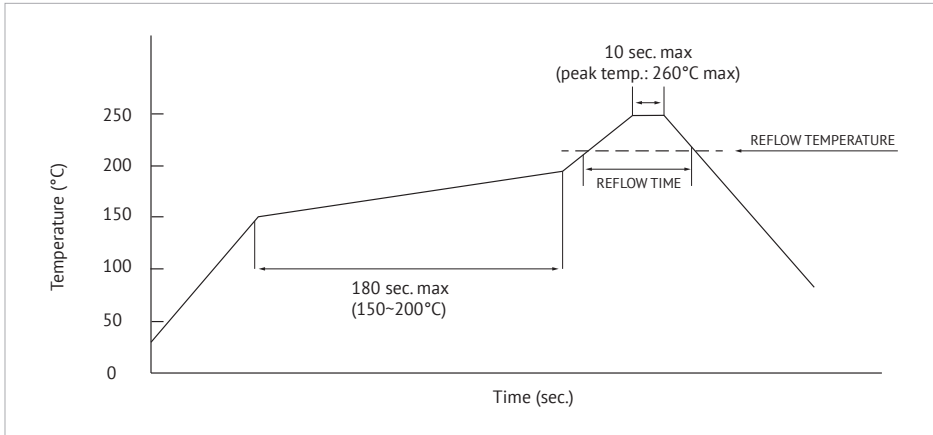

TEMPERATURE	TIME
255°C max	30sec. mx
230°C max	130sec. max
217°C max	150sec. max

RECOMMENDED REFLOW SOLDERING PROFILE (≥10V)

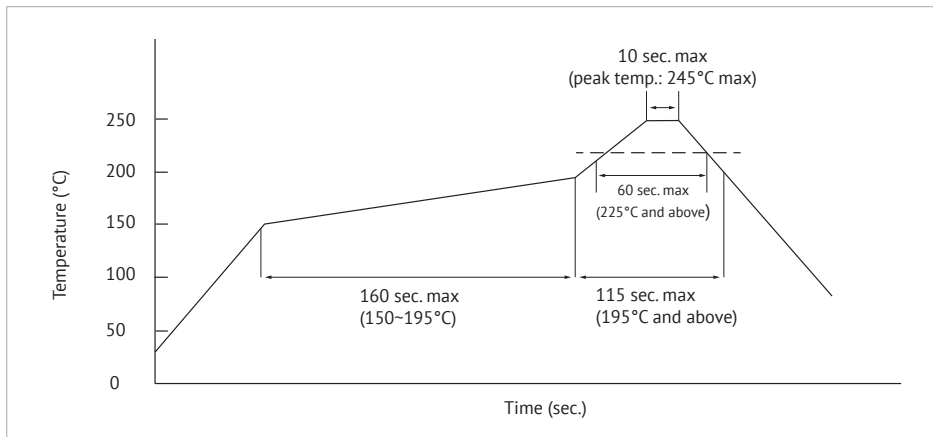

PACKAGING OUTER DIMENSIONS (Unit: mm)

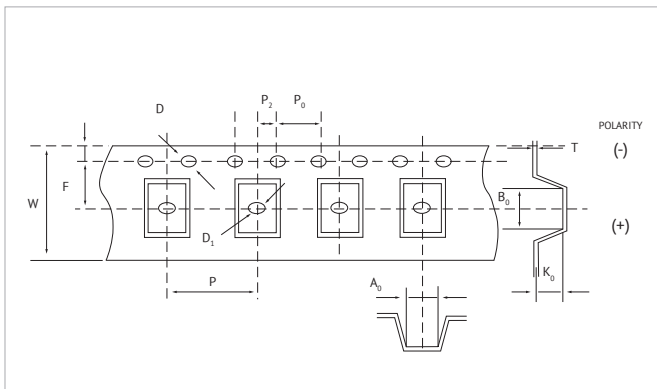

REEL STRUCTURE AND DIMENSIONS (Unit: mm)

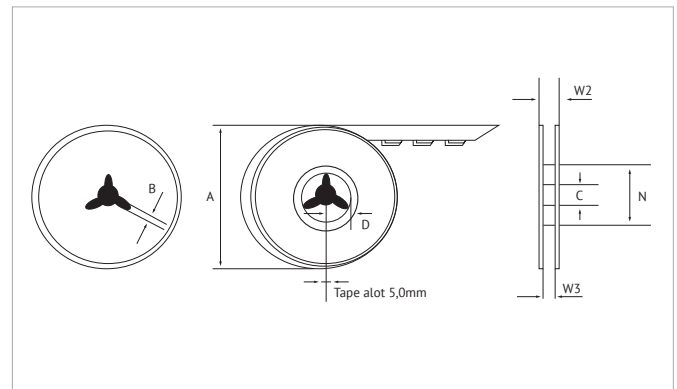

TYPE	W ±0,2	P ±0,2	A ₀ ±0,1	B ₀ ±0,1	K ₀ ±0,1	D ±0,1	D ₁ 0-0,25	E ±0,05	F ±0,05	P ₀ ±0,1	T ±0,005	P ₂ ±0,1
V	12,0	8,0	4,6	7,6	2,16	1,5	1,5	1,75	5,5	4,0	0,229	2,0
D	12,0	8,0	4,6	7,6	3,10	1,5	1,5	1,75	5,5	4,0	0,267	2,0
E	12,0	8,0	4,6	7,6	2,16	1,5	1,5	1,75	5,5	4,0	0,229	2,0
B	12,0	8,0	4,6	7,6	2,16	1,5	1,5	1,75	5,5	4,0	0,229	2,0

A±MAX	B±0,18	C±0,2	D±0,1	N±1,0	W2±1,0	W3±1,5
330	2,0	13,0	11,9	100	17,5	13,5

INTRODUCTION

INTRODUCTION SOLID POLYMER CAPACITORS

Aluminum Solid Electrolyte Capacitors with conductive polymer are aluminum electrolytic capacitors that use a solid polythiophene electrolyte system. The conductive polymer yields extremely low ESR-values that allow for very high ripple currents at high frequencies. Typically, these types of capacitors are used in smoothing circuits of DC-DC converters and in high-frequency applications. The rated voltage range of Polymer Capacitors from Jianghai has been extended to voltages up to 200V, which allows the usage in many power supply applications.

COMPARISON OF SOLID POLYMER CAPACITORS AND LIQUID ELECTROLYTIC CAPACITORS

The characteristics of solid capacitors differ from liquid capacitors in many ways. As the electrolytic system is implemented as a solid, dry substance, the limiting effect of drying-out known from liquid electrolytic capacitors does only have a minor impact on the lifetime. As a consequence, the temperature characteristics allow a usage in a wide range of ambient temperatures. Temperatures in the range from -55°C to 105°C lead merely to capacitance changes from 10...15%, while the ESR remains almost constant. The stability of its low ESR-values (especially in low temperature range) makes the polymer capacitor attractive for many applications. Compared to tantalum electrolytic capacitors, polymer capacitors offer a more reliable solution with a similar functionality.

LIFETIME

LIFETIME ESTIMATION SOLID POLYMER

Most lifetime tests for polymer capacitors are performed as a voltage-temperature test. The changes of the typical parameter like capacitance, leakage current and ohmic values are specified with a corresponding lifetime. Most lifetime models found in the literature on polymer capacitors are based on the such voltage-temperature tests without any additional current applied. As the capacitors are typically used under load conditions where ripple currents are present, most of the lifetime models do not meet the actual condition of usage well. Please take care when capacitors of different manufacturers are compared that similar lifetime test conditions have been deployed. The lifetime of solid polymer capacitors is affected by temperature, voltages, and the applied ripple currents generating heat due to power losses. But also additional factors like humidity or the impact of oxygen seeping in through the rubber seal are limiting the total lifetime. Oxidation and thermal degradation of the conductive polymer appear to be the dominant aging mechanisms. Jianghai offers a lifetime model for the estimation of the total lifetime of solid polymer capacitors that takes both the impact of the applied ripple current and the ambient temperature into account. In order to be comparable to other products available to the market, Jianghai defines the life time found on the datasheets as Endurance Lifetime L_e . The Endurance Lifetime is obtained by testing the capacitors at rated voltage and upper category temperature (i.e., without any ripple current applied) until a parametric failure is observed. For some high temperature series, current deratings for temperature >105°C need to be applied. Please check the individual datasheets carefully. Additionally, ΔT_0 shall be adapted depending on the temperature rating of the product. Please consult Jianghai Europe for lifetime estimations in case of doubt.

$$L = L_e \cdot 2^{\frac{(T_0 - T_A)}{10}} \cdot 2^{\frac{-\Delta T_0 \cdot \left(\frac{I_A}{I_R}\right)^2}{10}}$$

WHERE

- L Total Lifetime
- L_e Endurance Lifetime
- T_0 Upper Category Temperature
- T_A Ambient Temperature (in case of $T_A < 40^\circ\text{C}$ please take $T_A = 40^\circ\text{C}$)
- I_A Actual Ripple Current (at 100kHz)
- I_R Max. Allowed Rated Ripple Current (at 100kHz), see datasheet
Please note: $I_A \leq I_R$
- ΔT_0 For $T_0 \leq 105^\circ\text{C}$ capacitors: $\Delta T_0 = 20\text{K}$
For $T_0 > 105^\circ\text{C}$ capacitors: $\Delta T_0 = 20\text{K}$ for temperature range $T_A \leq 105^\circ\text{C}$
 $\Delta T_0 = 3\text{K}$ for temperature range $T_A > 105^\circ\text{C}$
Please consider additionally possible current deratings.

in mm

WARNING

JIANGHAI is not liable for any extent of possible injuries or damages to persons or things, of any kind, caused by the improper application of and/or operating conditions harmful to capacitors. Misapplications which may cause failures include, but are not limited to: ripple current or peak current or voltage above specification, operating voltage above the voltage specified, temperature exposure outside the specified operating temperature range. Examples of harmful operating conditions comprise, but are not limited to: unusual storage or transport temperatures, excessive and/or rapid changes of ambient temperature or humidity, heavy mechanical shock or vibration, corrosive and abrasive particles in the ambient (cooling) air, conducting dust in the ambient (cooling) air, oil or water vapor or corrosive substances, explosive gas or dust, operation under extremely high or low ambient pressure conditions (below or above sea level), superimposed radio frequency voltages, radioactivity. In case of doubt about the impact of operating conditions on capacitor performance, please contact JIANGHAI.

PERSONAL SAFETY

Electrical or mechanical misapplication of electrolytic capacitors may be hazardous. Personal injury or property damage may result from explosion of a capacitor or from the expulsion of electrolyte due to mechanical disruption or the release of a safety vent of a capacitor. In case of injury or skin or eye exposure to electrolyte, immediately seek professional medical advice. Before using capacitors in any application, please read these Handling Precautions, familiarizing thoroughly with the information contained herein. Please check before using any of our capacitors if these components fulfill the requirements of your application and that warnings and instructions for use are followed.

WARRANTY

The information contained in this catalogue does not form part of any quotation or contract, is believed to be accurate, reliable and up to date. Quality data are based on the statistical evaluations of a large quantity of parts and do not constitute a guarantee in a legal sense. However, agreement on these specifications does mean that the customer may claim for replacement of individual defective capacitors within the terms of delivery. We will not assume any liability beyond the replacement of defective components. This applies in particular to any consequential damage caused by component failure. Furthermore, it must be taken into consideration that the figures stated for lifetime, failure rates and outlier percentages refer to the average production status and are therefore to be understood as mean values (statistic expectations) for a large number of delivery lots of identical capacitors. These figures are based on application experience and data obtained from preceding tests under normal conditions, or – for purpose of accelerated aging – more severe conditions.

JIANGHAI reserves the right to change these specifications without prior notice. Any application information given is advisory and does not form part of any specification. The products are not primarily designed for use in life support applications, devices or systems where malfunction of these products can reasonably be expected to result in personal injury. JIANGHAI customers using or selling these products for use in such applications without prior written consent of JIANGHAI do so at their own risk and agree fully to indemnify JIANGHAI for any damage resulting from such improper use or sale. This version of the catalogue supersedes all previous versions. Latest versions of datasheets can be found on our homepage: www.jianghai-europe.com.

POLARITY

Polymer capacitors are polar and shall never be used with incorrect polarity, as there is a possible danger of shorting or destruction.

RATED VOLTAGE U_R

The rated voltage is marked on the capacitor and defined in the datasheets as U_R . This voltage should never be exceeded and is the maximum peak voltage including any ripple voltages allowed to avoid a shortening of the lifetime or damage of the capacitor. When a ripple current is applied to the capacitor, the sum of the peak ripple voltage and bias DC voltage shall never exceed the rated voltage. It might be necessary to lower the maximum allowed bias DC voltage, when certain ripple currents are applied to the capacitor.

REVERSE VOLTAGE

Reverse voltages or voltages $<0V$ are not allowed.

OVER-VOLTAGE / SURGE VOLTAGE

Over-voltages higher than the rated voltage will destroy the capacitors and must be avoided. The sum of DC voltage and the ripple voltage peak must not exceed the rated voltage.

LOW VOLTAGE

If the rated voltage is low, take care that any negative ripple voltage peak does not become a reverse voltage. Ripple voltages shall never become larger than $0,1 \cdot U_R$.

RECOVERY VOLTAGE

Electric potential between the positive and negative terminal may exist as a result of dielectric absorption. Please take action that this load does not damage other devices or scare workers during the production process (sparks possible). If needed please discharge the capacitor through a $1k\Omega$ resistor.

TEMPERATURE RANGE

Use solid polymer and hybrid capacitors only within the specified operating temperature range.

OVER-CURRENT

Ripple currents above the specified rating must be avoided as they may damage the capacitor.

RIPPLE CURRENT/VOLTAGE

The combined value of DC voltage and peak AC voltage (due to

ripple current) shall not exceed the rated voltage and shall never be $<0V$. Use of solid polymer and hybrid electrolytic capacitors under ripple current with wide amplitudes is equivalent to rapid charge-discharge operation.

RAPID CHARGING/DISCHARGING

Rapid charging/discharging generates severe heat and gas may be emitted which may lead to explosion. Consult JIANGHAI about specially designed capacitors suitable for such kind of applications.

Example: Servo Drive Application

SERIAL CONNECTION

Serial connections shall be avoided to prevent possible overvoltage conditions.

PARALLEL CONNECTION

When parallel connections between polymer capacitors are planned, please take proper current balancing into account.

INRUSH CURRENT LIMITATION

Use a protection circuit when the inrush current exceeds 10A. Especially higher voltage capacitor might need an individual protection against high inrush currents.

SHORT-CIRCUIT PROTECTION

Protect solid polymer and hybrid capacitors from short-circuiting. Such high currents might destroy the capacitor and in rare cases ignite the rubber inside the capacitor.

LEAKAGE CURRENT

Leakage Currents might increase as consequence of longer storage, critical soldering processes, overload conditions, heavy charging/discharging, mechanical stress. Please note that solid polymer capacitors need a longer time for an internal repair than liquid capacitors like hybrid capacitors. An increase of the leakage current shall be taken as an indication of a possible damage and should be avoided generally. It is essential to ensure a correct soldering profile. Please follow the recommendation of Jianghai. In case of any questions please contact Jianghai Europe.

LIFETIME

There are many different lifetime definitions known without any true industry standard. Take special care when capacitors are compared that the capacitors fulfill the needed requirements. JIANGHAI publishes all conditions to be as transparent as possible. In the case of lifetime tests with additional ripple current, the bias DC voltage must be reduced, so that the sum of bias DC voltage and the peak of the ripple voltage does not exceed the Rated Voltage U_R .

LIMITATION ON USAGE

Polymer Capacitors cannot be used:

- in circuits with frequent and/or rapid charging and discharging function,
- in time-constant or coupling circuits,
- in high impedance circuits or applications, where the leakage current affects the circuit operation,

- after heavy thermal stress during soldering as the capacitance and leakage current may change,
- under mechanical stress. Avoid mechanical vibration and shock.
- in applications with heavy discharges / negative transients higher than 10% of U_R .

VIBRATION AND MECHANICAL STRESS

Capacitors are sensitive to vibration and mechanical forces applied to the leads. Do not use capacitors which have been dropped onto a rigid surface.

INSULATION

If any defect of the sleeve is visible, the component should not be used – the same holds for any kind of visible damage. A capacitor should be electrically isolated from the following parts: aluminum case, cathode lead wire, anode lead wire and circuit pattern. The sleeve is not recognized as an isolator and therefore the standard capacitor should not be used in a place where insulation function is needed. Laminated capacitors need to be handled like non-isolated components. Please take care of a complete separation of the lead wires and the case of the capacitor. Please contact JIANGHAI if a higher grade of insulation is required.

CURRENT DERATING

For Polymer Capacitors of $>105^{\circ}C$ temperature class, current deratings for temperatures $>105^{\circ}C$ might be necessary. Please check carefully the individual datasheet.

SAFETY OF DESIGN

Always consider the safety when designing circuits. Plan for worst case failures such as short circuits and open circuits. Never reuse capacitors if they have been assembled and energized already.

HIGH RELIABILITY LIMITATION

Without written consent by Jianghai, Polymer capacitors should not be used in highly reliable or life sustaining applications such as: medical equipment, aviation/aerospace equipment, automotive and nuclear applications and others, where a capacitor failure may have a major impact.

ENVIRONMENTAL CONDITIONS

Avoid direct contact with water, salt solution, oil, dewing conditions. Halogens generally, especially fumigation treatment with bromides and flame retardant agents containing halogens must be avoided. Avoid exposing to direct sunshine, ozone, ultraviolet rays and x-ray radiation. Air Pressure: Max. 150kPa, min. 8kPa. For usage $>2000m$ altitude above sea level current deratings might be necessary. No heavy air pressure changes are allowed. Do not use or store in an environment containing any hazardous gas (e.g., hydrogen sulphide, sulphurous acid, nitrous acid, chlorine, ammonia, bromine, methyl bromide, other halogens, noxious gases) or acidic or alkaline solutions.

STORAGE

Temperature 5 to $30^{\circ}C$, relative humidity below 60%. These capacitors may accumulate charge naturally during storage. In

this case discharge through a 1kOhm resistor before use (recovery voltage). Leakage current may be increased after long storage time. In order to keep a good solderability, store the capacitors in plastic bags. The maximum storage time shall be limited to one year. Stacked solid polymer capacitors do have additional instructions, see datasheet.

SOLDERING

Soldering conditions (temperature, times) should be within specified conditions, especially for SMT components. Avoid high soldering temperatures as this may reduce lifetime or damage the capacitor. Do never dip the capacitor body into molten solder. Flux should not be adhered to the capacitor's body but only to its terminals. For details and different methods please contact us.

GLUEING, CLEANING AND COATING

Do not use fixing agents or cleaning substances containing halogens. Do not use coating and moulding components that completely seal the capacitor from the environment. Also, never use solvents containing: halogenated hydrocarbons, alkali, petroleum, trichloroethylene/-ethane, xylene, acetones, trichlorotrifluoroethane, tetrachloroethylene, methylenechloride, chloroform, acetates, ketones, esters, chlorides and bromides. If a circuit board cleaning is planned, please contact Jianghai Europe for approval of the cleaning process to avoid damages of the capacitors.

MOUNTING

Other devices, which are mounted near the capacitor, should not touch the capacitor. Additional heat coming from other components near the capacitor may reduce the lifetime of the capacitor. Do never bend or twist the capacitor after soldering to avoid stress on the leads. Radial capacitors are not protected against mechanical forces on the leads. Forces on the pins might damage the capacitor. No printed circuit board tracks are allowed between the lead pads of the capacitor. Screw Terminal capacitors should only be mounted in an upright position.

TRANSPORT

Avoid fumigation and spraying insecticides (especially with bromides) in the import or export procedures which can cause corrosion. This applies also to the finished devices.

MAINTENANCE

Periodical inspection should be carried out for the capacitor: visual inspection to check pressure relief open or leakage of electrolyte, electrical characteristics as leakage current, capacitance, and dissipation factor.

ELECTROLYTE AND SEPARATOR PAPER

Electrolyte and separator paper used in solid polymer or hybrid capacitors may be flammable. Also, electrolyte is electrically conductive. Therefore, in case electrolyte gets in contact with PC board it may cause corrosion of circuit pattern or cause short circuit between patterns, and may lead to smoke generation or ignition in worst case.

CAUTION DURING USE OF CAPACITORS

Do not touch the terminals of capacitors. Keep the capacitor free from conductive solution, such as acids, alkali and so on. Ensure that the operating environment of the equipment into which the capacitor has been built is within the specified conditions mentioned in the catalogue or specification sheets.

SAFETY VENT

The safety vent needs some free space to open properly. Allow for free headroom of at least 2mm for diameter ≤ 16 mm, more than 3mm for diameter 18-35mm, more than 5mm for case diameter 40mm and larger.

EMERGENCY ACTIONS

When the pressure relief vent is open and some gas blows out from the capacitor, please turn the mains switch of the equipment off or pull out the plug from the power outlet immediately. During safety vent operation, extremely hot gas ($>100^{\circ}\text{C}$) may blow out of the capacitors. Do not stand close to the capacitors. In case of eye contact, rinse the open eye(s) with clean water immediately. In case of ingestion, gargle with water immediately, do not swallow. Do not touch electrolyte but wash skin with soap and water in case of skin contact. After exposure, consult a physician.

DEFINITION OF ELECTRICAL PARAMETERS

Separate documents as application notes, equivalent circuit diagrams and so on are available on request.

DISPOSAL

Capacitors going out of service are classified as scrapped metal. For disposal they are handled as controllable industrial waste because of the nature of the contents (electrolyte). Most of the material is aluminum and cannot be completely burned.

Jianghai Europe Electronic Components GmbH
VERSION 01/2024